

BFR370F MICROWAVE LOW NOISE SILICON BIPOLAR RF TRANSISTOR

1. 简述:

- ✦ 适合于小电流的高频微波低噪声放大器以及集电极在 3.3~5V 的直流电源电压;
- ✦ 能适应于高达 4.0 GHz 的振荡电路的信号放大;
- ✦ 在 1.8GHz 时的噪声约为 1.0dB;
- ✦ 低漏电流、小结电容特性, 较大的动态范围, 理想的电流线性;
- ✦ 采用无铅 (Pb-free、RoHS compliant) 工艺的表面贴 SOT323 封装;
- ✦ 主要用于电视调谐器、卫星电视接收器、CATV 视频放大器、模拟数字无绳电话、雷达感应开关、无线遥控数传、无线通信、RFID 散射式射频识别系统、光纤放大器等产品中, 用于 VHF/UHF 放大器、振荡器、混频器、检波器, 以及高频微波信号发射与接收电路中的信号放大;

✦ 封装形式: SOT323, 本体印字(Marking): FDs.

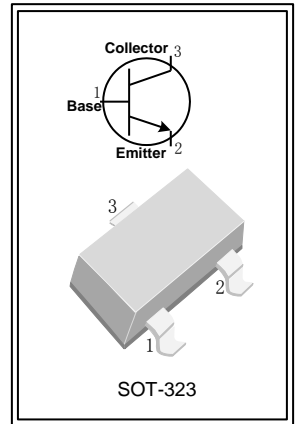

2. 极限参数 (Tamb=25℃):

参数名称	符号	额定值	单位
集电极-基极击穿电压	BV _{CB0}	15	V
集电极-发射极击穿电压	BV _{CEO}	6	V
发射极-基极击穿电压	BV _{EB0}	2	V
集电极电流	I _C	50	mA
耗散功率	P _T	300	mW
最高结温	T _J	150	℃
储存温度	T _{stg}	-65 ~ +150	℃

3. 电参数及规格 (Tamb=25℃):

参数名称	符号	测试条件	最小值	典型值	最大值	单位
集电极发射极击穿电压	BV _{CEO}	I _C =1mA, I _B =0	6	9	-	V
集电极发射极截止电流	I _{CES}	V _{CE} =4V, V _{BE} =0	-	1	30	nA
集电极基极截止电流	I _{CB0}	V _{CB} =6V, I _E =0	-	1	30	nA
发射极基极截止电流	I _{EBO}	V _{EB} =6V, I _C =0	-	1	500	nA
直流电流放大系数	h _{FE}	V _{CE} =3V, I _C =20mA	90	120	160	-
特征频率	f _T	V _{CE} =3V, I _C =20mA, f=1GHz	11	14	-	GHz
反馈电容	C _{re}	I _C =I _E =0, V _{CB} =5V, f=1MHz	-	0.22	-	pF
集电极电容	C _c	I _E =I _E =0, V _{CB} =5V, f=1MHz	-	0.4	0.5	pF
发射极电容	C _e	I _C =I _C =0, V _{EB} =0.5V, f=1MHz	-	0.42	-	pF
插入功率增益	S ₂₁ ²	V _{CE} =5V, I _C =20mA, f=1.8GHz	-	12.8	-	dB
		V _{CE} =5V, I _C =20mA, f=3.0GHz	-	8.8	-	dB
噪声系数	NF	V _{CE} =3V, I _C =3mA, f=1.8GHz	-	1.0	-	dB
最大单边功率增益	G _{UM}	V _{CE} =5V, I _C =20mA, f=1.8GHz	-	15	-	dB
		V _{CE} =5V, I _C =20mA, f=3.0GHz	-	10.5	-	dB
输出端第三阶截取点增益	IP3	V _{CE} =3V, I _C =20mA, Z _S =Z _L =50Ω, f=1.8GHz	-	22	-	dBm

$$\text{其中: } G_{UM} = 10 \log \frac{|S_{21}|^2}{(1 - S_{11})^2 (1 - S_{22})^2} \text{ dB}$$

5. 典型特征曲线:

TYPICAL CHARACTERISTICS
($T_A=25^{\circ}\text{C}$, unless otherwise specified)

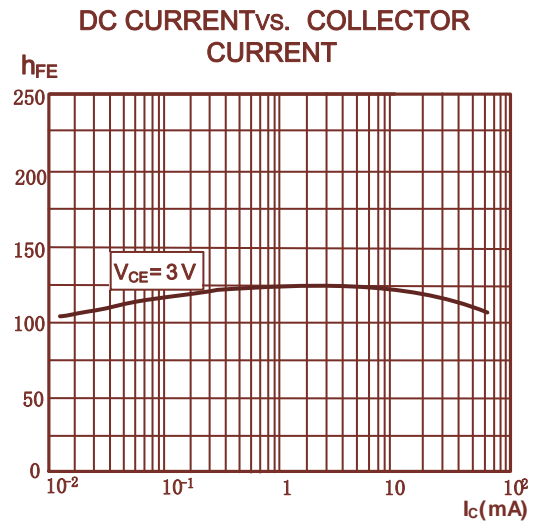
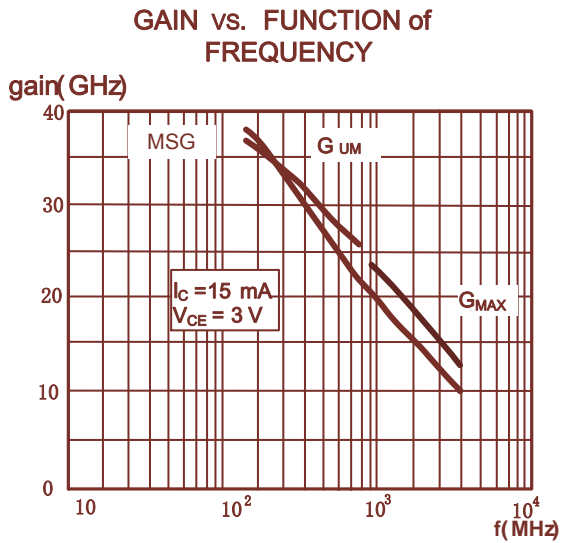
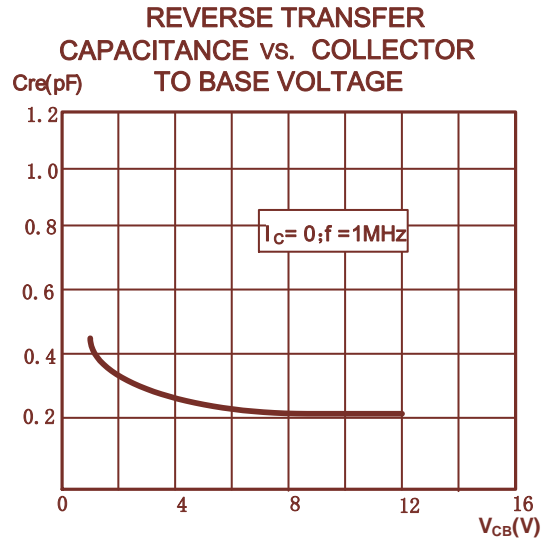
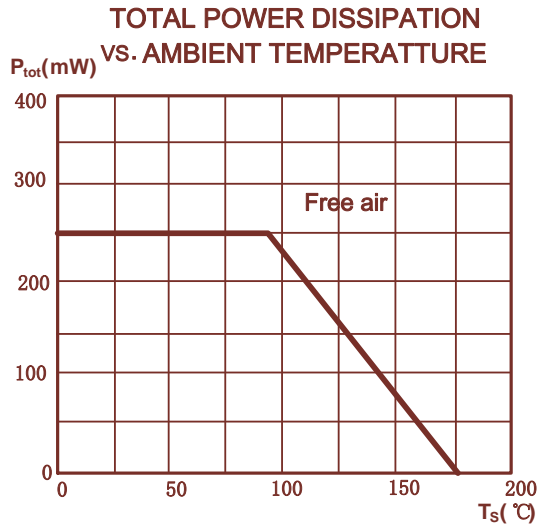

GAIN vs. FUNCTION of COLLECTOR CURRENT

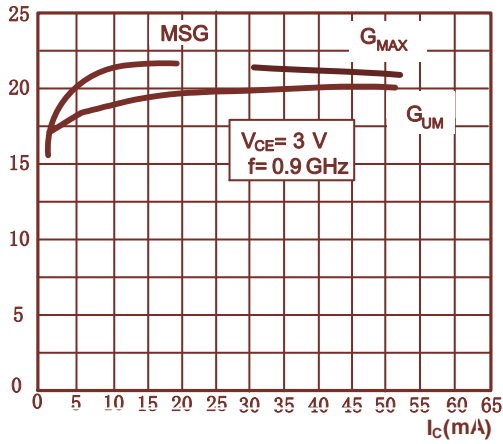

GAIN vs. FUNCTION of COLLECTOR CURRENT

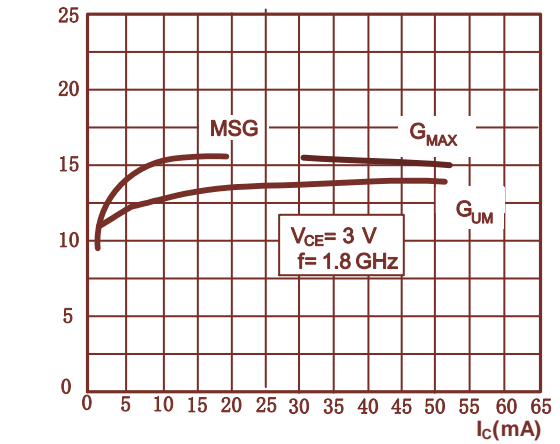

GAIN vs. FUNCTION of COLLECTOR CURRENT

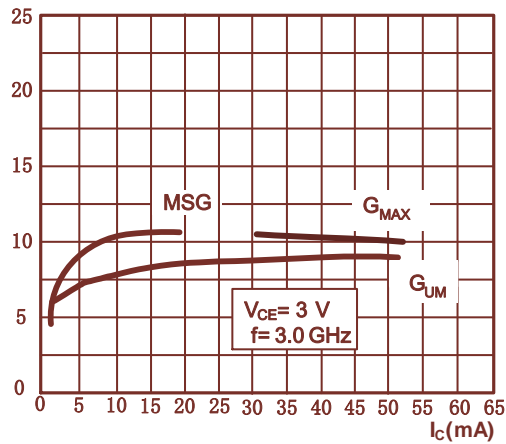

NOISE FIGURE vs. COLLECTOR CURRENT

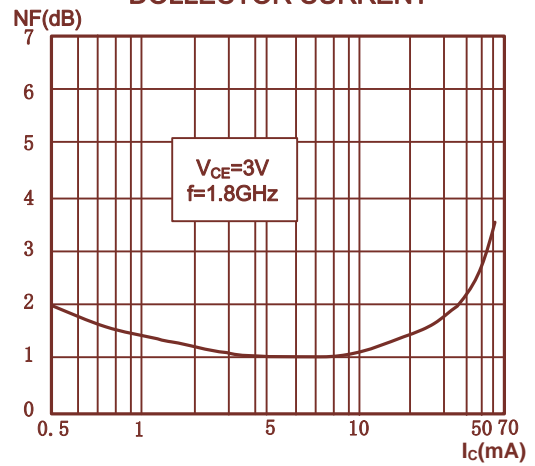

6. 封装尺寸示意图:

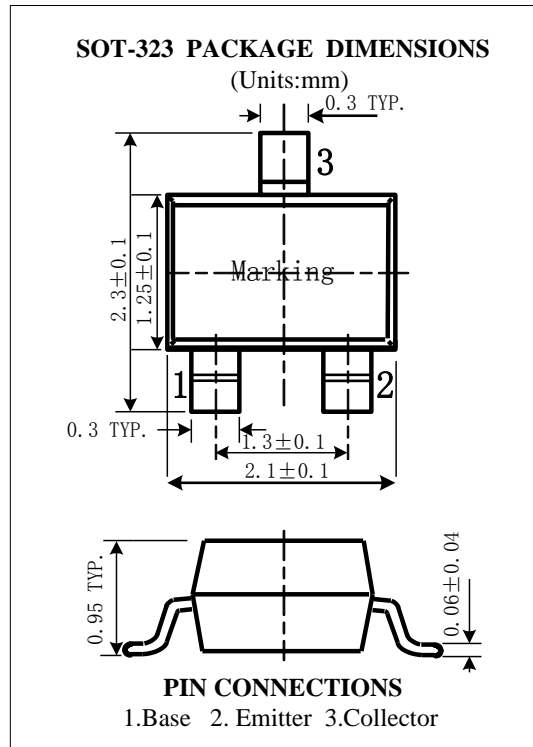

7. 包装信息:

PACKAGE INFORMATION

封装形式 Package	数量/盘 Shipping	盘/中盒 Inner Box	中盒/箱 Carton
SOT-323	3000pcs/Tape&Reel	10 Tape&Reel	4 Inner Box