

BFR520 NPN TRANSISTOR

MICROWAVE LOW NOISE AMPLIFIER NPN SILICON EPITAXIAL TRANSISTOR

1. 简述:

本芯片采用硅外延工艺制造, 具有高功率增益放大、宽带以及低噪声、低漏电流、小结电容特性, 较大的动态范围, 理想的电流线性;

主要应用于超高频微波、VHF、UHF 和 CATV 高频宽带低噪声放大器中,

如卫星电视调谐器、CATV 放大器、模拟数字无绳电话、雷达探测器、射频模块和 光纤传输中的中继放大器等产品;

集电极-发射极击穿电压: $BV_{CEO}=15V$, 最大集电极电流: $I_C=70mA$, 集电极耗散功率: $P_C=300mW$, 特征频率: $f_T=9GHz$;

封装形式: SOT23, 本体印字(Marking): 32W, N2, N2t.

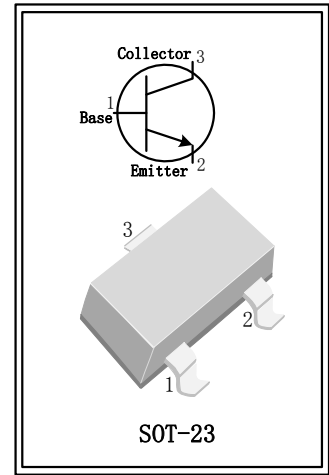

2. 极限参数 ($T_{amb}=25^{\circ}C$):

参数名称	符号	额定值	单位
集电极-基极击穿电压	BV_{CBO}	20	V
集电极-发射极击穿电压	BV_{CEO}	15	V
发射极-基极击穿电压	BV_{EBO}	2.5	V
集电极电流	I_C	70	mA
耗散功率	P_T	300	mW
最高结温	T_J	150	$^{\circ}C$
储存温度	T_{stg}	-65 ~ +150	$^{\circ}C$

3. 电参数及规格 ($T_{amb}=25^{\circ}C$):

参数名称	符号	测试条件	最小值	典型值	最大值	单位
集电极截止电流	I_{CBO}	$V_{CB}=6V, I_E=0$	-	-	0.05	μA
直流电流放大系数	h_{FE}	$V_{CE}=6V, I_C=20mA$	60	120	250	
特征频率	f_T	$V_{CE}=6V, I_C=20mA$	-	9	-	GHz
反馈电容	C_{re}	$I_C=I_C=0, V_{CB}=6V, f=1MHz$	-	0.4	-	pF
集电极电容	C_C	$I_E=I_E=0, V_{CB}=6V, f=1MHz$	-	0.5	-	pF
发射极电容	C_e	$I_C=I_C=0, V_{EB}=0.5V, f=1MHz$	-	1.0	-	pF
插入功率增益	$ S_{21} ^2$	$I_C=20mA, V_{CE}=6V, f=900MHz$	13	14	-	dB
		$V_{CE}=6V, I_C=5mA, f=900MHz$	-	1.1	1.6	dB
		$V_{CE}=6V, I_C=20mA, f=900MHz$	-	1.6	2.1	dB
噪声系数	NF	$V_{CE}=8V, I_C=5mA, f=2GHz$	-	1.9	-	dB
		$I_C=20mA, V_{CE}=6V, f=900MHz$	-	15	-	dB
最大单边功率增益	G_{UM}	$I_C=20mA, V_{CE}=6V, f=2GHz$	-	9	-	dB
		输出电容	V_O	270		mV
输出功率在 1dB 的增益压缩	$PL1$	$I_C=20mA, V_{CE}=6V, V_O=75mV, f=810MHz$	-	-50	-	dB

其中：
$$G_{UM} = 10 \log \frac{|S_{21}|^2}{(1 - S_{11})^2 (1 - S_{22})^2} \text{ dB}$$

5. 典型特征曲线:

TYPICAL CHARACTERISTICS
($T_A=25^\circ\text{C}$, unless otherwise specified)

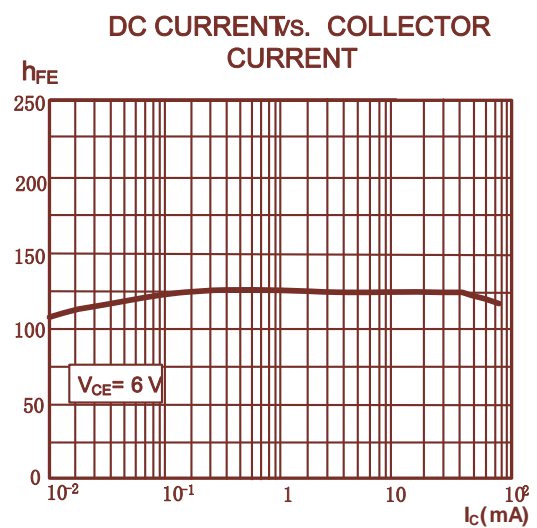
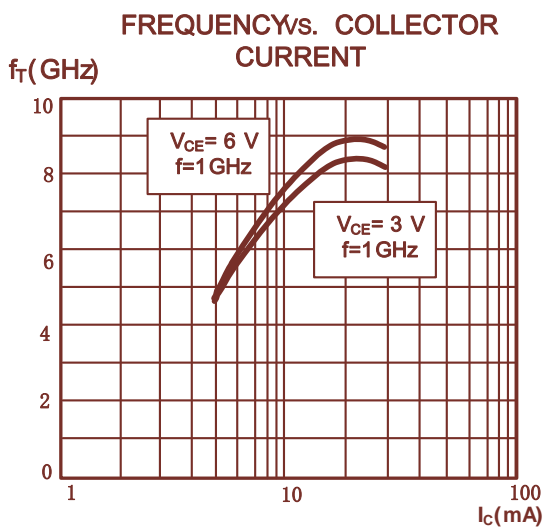
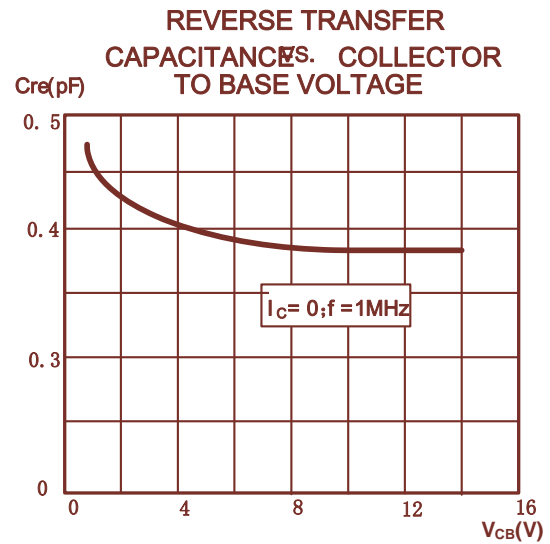
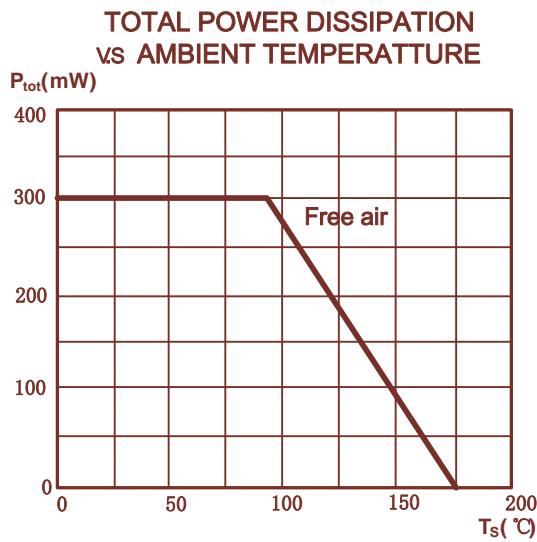

GAIN vs. FUNCTION of COLLECTOR CURRENT

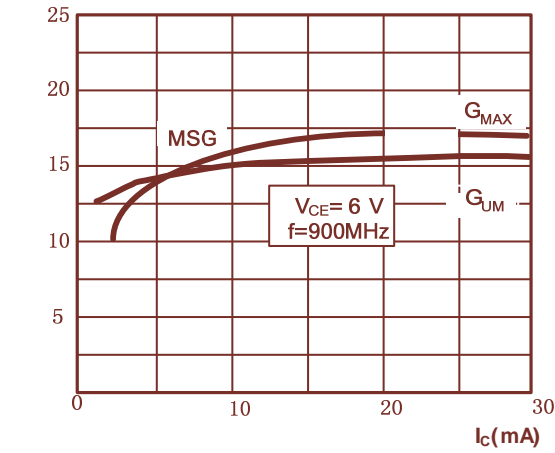

GAIN vs. FUNCTION of COLLECTOR CURRENT

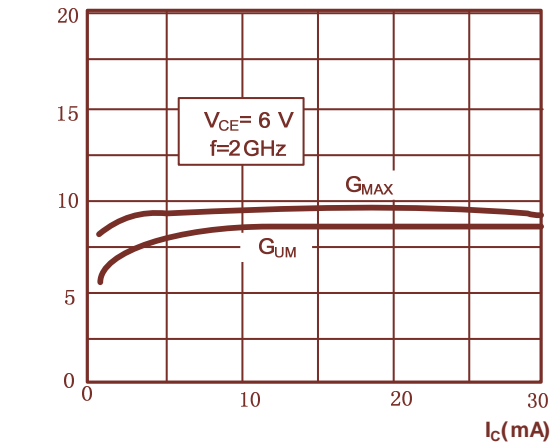

vs. FUNCTION of COLLECTOR CURRENT

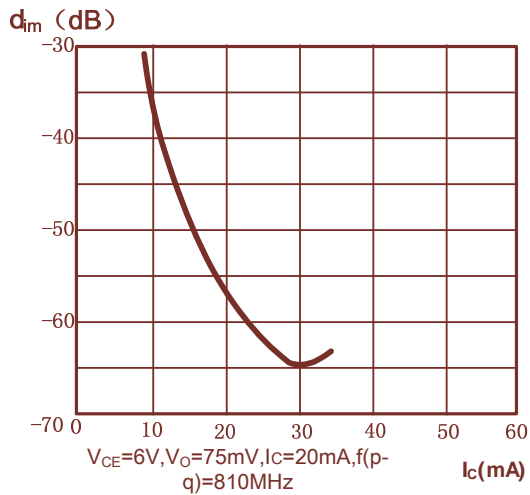

DISTORTION vs. FUNCTION of COLLECTOR CURRENT

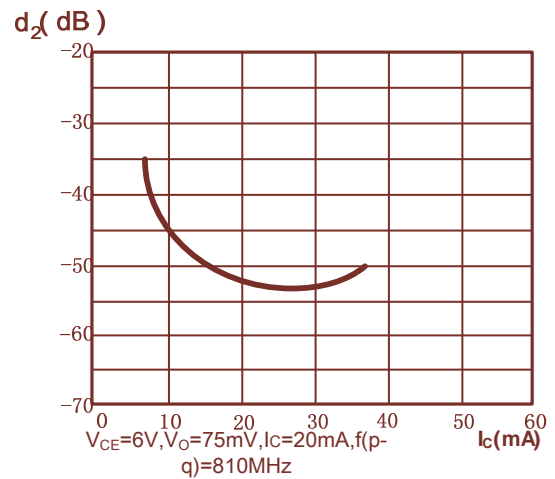

GAIN vs. FUNCTION of FREQUENCY

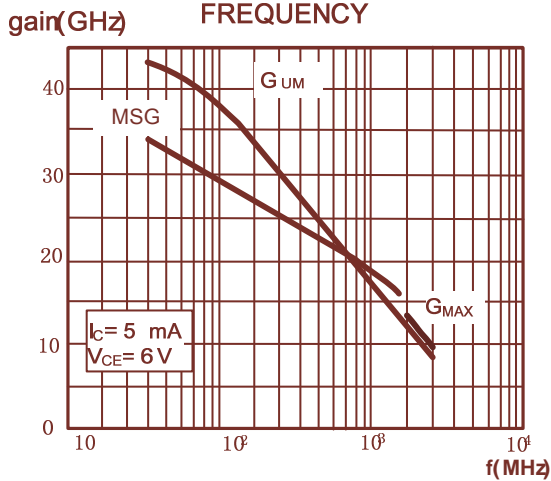

GAIN vs. FUNCTION of FREQUENCY

